





Vacuum Pumps America Inc.

Air Cooled Dry Screw Vacuum Pump VPA-ASP50 & VPA-ASP50/Ex



VPA-ASP50/Ex with explosion proof motor and cover

Features of VPA-ASP50 and VPA-ASP50/Ex, Air Cooled Dry Screw Vacuum Pumps:

- Air cooled design. No need for water cooling, heat exchanger or any other cooling liquid.
- Corrosion Proof, Rugged and Robust design. Capable of handling all types of Corrosive Gases, Organic Vapors and Organic Solvents.
- Suitable for creating clean vacuum and oil free clean vacuum.
- All wetted material including Vacuum Pump Housing and Screw Rotors are TEFLON Coated.
- Capable of handling all types of gases in any application ideal for: Pharmaceutical Industries, Food Processing Plants, CBD and THC Extraction Plants, Particle accelerators, CANDU Reactors, Nuclear Waste Management, PWR Reactors, Semiconductor Industries, Bio-Fuel processing etc.
- Reduced discharge temperature greatly to T5 and T6 for Hazardous area including Explosion Proof versions  and ATEX versions .
- Small foot print, compact design and proven quality.
- Low noise and vibration due to completely balanced screws.
- No use of Oil or Water as pumping medium, low operation costs and low cost of ownership.
- No oil back migration and no oil back streaming.
- Advanced design for Screw Rotors doesn't let the bearings and seals come in contact with gases, vapors and even liquids.
- Gravity drain for liquids and condensations through the exhaust silencer and trap.
- High Performance and High Efficiency.
- Short gas path through the pump makes quick gas discharge.
- Easy on-site maintenance and cleaning.
- VPA-ASP50 and VPA-ASP50/Ex Dry Screw Vacuum Pumps are available with Regular, Explosion Proof , ATEX  and Stainless Steel motors at different voltages: 380V, 400V, 415V, 230/460V and 575V @ 50/60Hz with CE, CSA or UL approvals.
- VPA-ASP50/Ex are Air Cooled Dry Screw Vacuum Pumps and can handle all types of Corrosive gases, Petrochemical vapors, Organic Solvents and Biologic vapors in hazardous area like: Acetone, Bio Diesel, Butane, Isobutene, Propane, THF, Oxalane, Dimethyl Ether DME, Diflouroethane HFC, Tetraflouroethane, Pentane, Carbon Dioxide, Methylated spirits, Methanol, Ethanol, Propanol, Xylene, Toluene, Methyl Ethyl Ketone, Alcohols, Benzene, Acetates, Ethylene Dichloride, Pentane, Adhesives, Ethylene Oxide, Phenol, Aldehydes, Fatty acids, Phosgene, Glycerides, Phosphoric Acid, Amines, Halides (HCl, HBr, HF), Polycarbonates, Aromatics, Hexane, Polyglycols, Ammonia, Hydrocarbons, Sulphides, Benzene, Hydrogen, Sulphuric Acid, Biofuels, Isocyanates, Siloxanes, Bromides, Ketones, Thionyl Chloride, Chlorides, Mineral acids, Dimethyl Sulphide, Triethylamine, Diols, etc..

e-mail: sales@vpamerica.com , Phone: 416-407-0350

Specifications of VPA-ASP50 & VPA-ASP50/Ex Air Cooled Dry Screw Vacuum Pumps:

Model	Pumping Speed L/min m ³ /h CFM	Ultimate Pressure (Torr)	Power (kW)	Motor Rotational Speed (min ⁻¹)	Inlet	Outlet	Nitrogen Purge Pressure (psig)	Oil Capacity (L)	Estimated Weight (kg)
VPA-ASP50 & VPA-ASP50/Ex	@ 60Hz 833	7.5 x 10 ⁻³	2.2	3600	KF40	KF25	7.25 to 29	0.25	100
	50								125
VPA-ASP40 & VPA-ASP40/Ex	@ 50Hz 700	7.5 x 10 ⁻³	2.2	3600	KF40	KF25	7.25 to 29	0.25	100
	42								125
	30								
	25								



*Operating Temperature: 5°C to 40°C





**Specifications are subjected to change without notice to improve product quality.

*** To convert m³/h to CFM, divide by 1.69, Example: 100 m³/h ÷ 1.69= 72CFM

Applications of VPA-ASP50/Ex & VPA-ASP50 Air Cooled Dry Screw Vacuum Pumps:

Autoclaves
Automotive
Backing pump for high vacuum pumps
Backing pump for Turbopumps
Brake Fluid Filling Systems
Brazing
Casting
CANDU Reactors

Chemical Distillation 
Chemical Processing 
Chemical Laboratories 
Chemical Vapor Deposition
CVD Coating Systems
Corrosive Gases

Central Vacuum Systems 
Debinderization
Degassers 
Degassing 
Drying 
Freeze Drying
Etching
Etchers and Dry Etchers
Evacuating of Refrigeration Systems

Evacuation of Process chambers 
Forming
Food Processing
Food Industry
Fermentation
Freeze Drying

Hazardous area 
Heat Treatment
Heat Exchanger Drying in Power Plants

Hazardous Area 
Impregnating 
Investment Casting 
Impregnation 
Isotope Separation
Laboratory
Leak Detection of dry systems
Light Bulb Manufacturing
Liquid Gas Storage
Lyophilizers
Metallurgy
Metals Processing

Oil Degassers 

Nuclear Waste Management

Nuclear Reactors
Packaging
PET Processing

Pharmaceutical Processes 
Physical Vapour Deposition PVD
PVD Coating Systems
Physics Laboratories
Potting
Research & Development

Refineries 
Roll Coating
Semiconductor Industries
Semiconductors
Silicon Crystal Growing
Sintering
Space Simulation
Solvent Recovery 
Solvent handling 
Transformer Drying 
Vacuum Coating
Vacuum Furnaces
Vacuum Heat Treating
Vacuum Melting
Vacuum Metalizing
Vacuum Packaging
Vacuum Metallurgy
e-mail: sales@vpamerica.com,
Phone: 416-407-0350

Performance curves for VPA-ASP50 and VPA-ASP50/Ex:

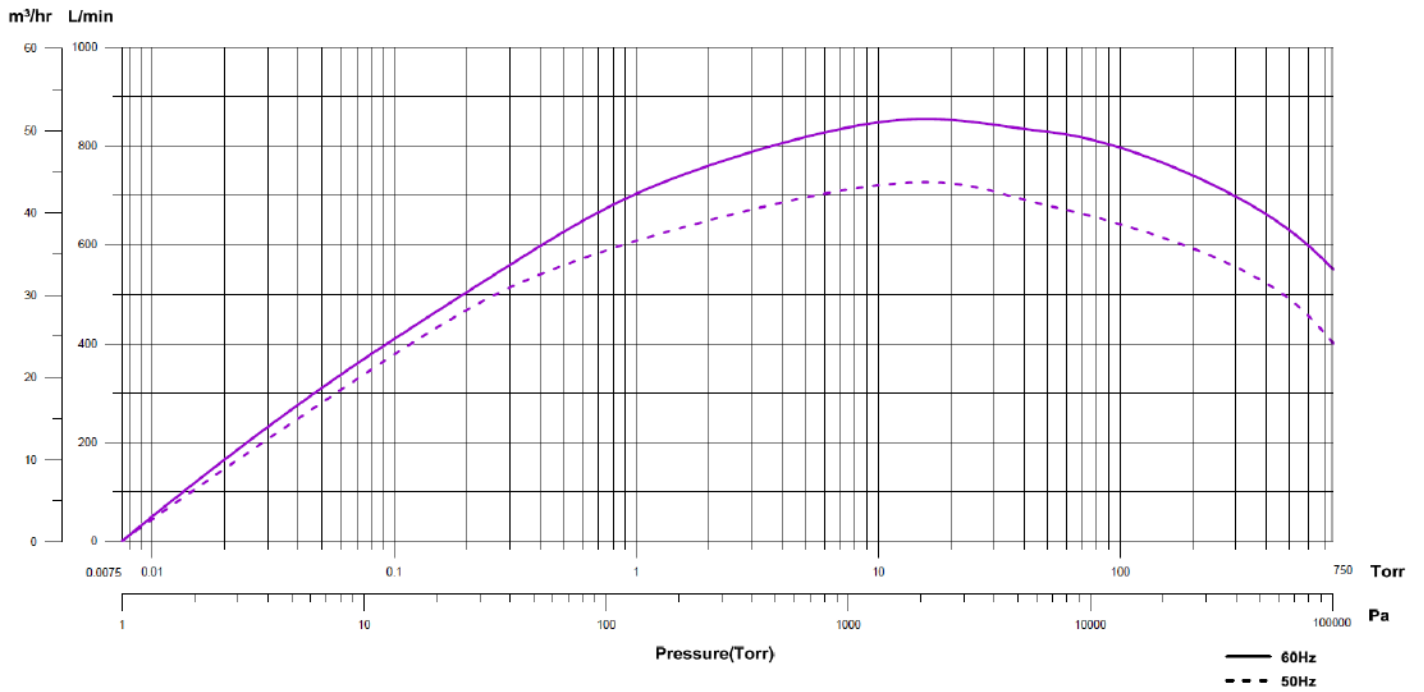

Dimensions for VPA-ASP50 Air Cooled Dry Screw Vacuum Pump

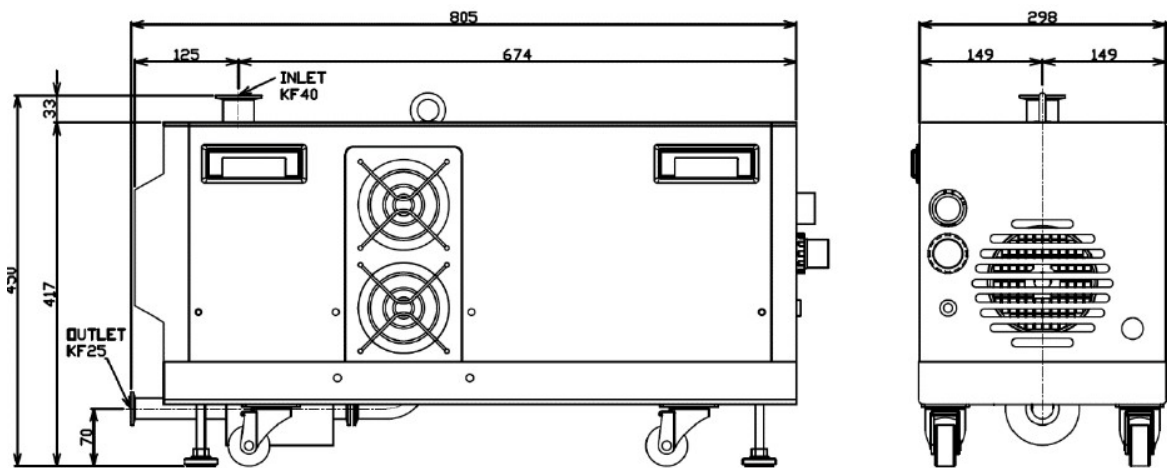

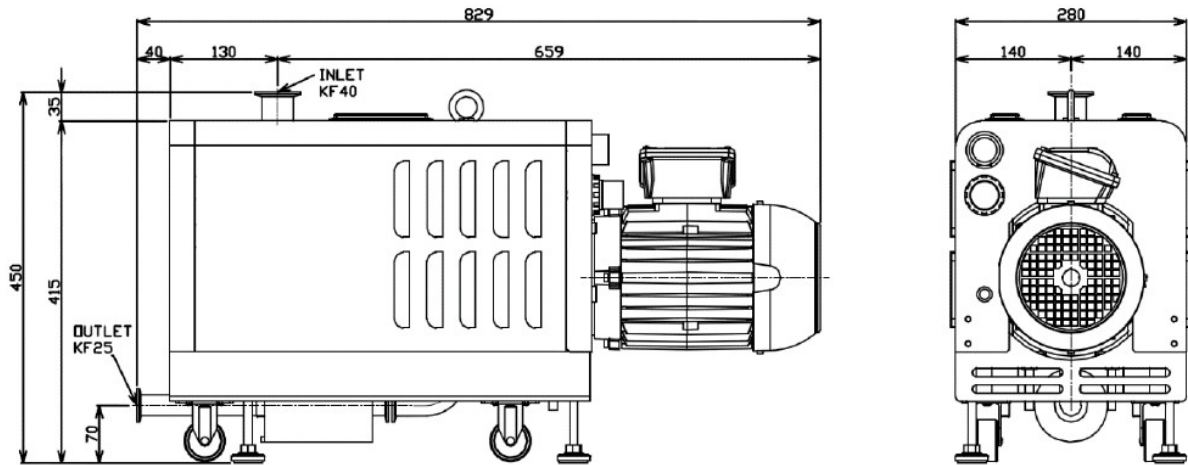

Dimensions for VPA-ASP50/Ex Air Cooled Dry Screw Vacuum Pump with Explosion Proof Motor



*Length for the VPA-ASP50/Ex is different by using different types of motors. All dimensions are in millimeter.

Different types of motors available for VPA-ASP50 and VPA-ASP50/Ex Dry Screw Vacuum Pumps as follows:

- Explosion proof, Class 1, Division 1, Group C&D. Other Classes, Divisions and Groups available upon request.
- ATEX 
- Conventional TEFC
- Energy efficient
- Flame proof 
- Stainless Steel and Wash down
- Motors are compatible with CE, CSA or UL standards.

For more information, please contact: **E-mail: sales@vpamerica.com or Phone: 416-407-0350**