



SECTION CONTENTS

CENTERING RING SERIES

General Information	8- I ..
Temperature Range of Generic Elastomers	8- III ..
Relation Between O'ring Wire Diameter & Inside Diameter	8- VI ..
AS568 DASH Numbers	8- VII ..
JIS B2401 O-Ring Sizes	8- IX ..
Durometer Chart	8- XIV ..
O'ring Test Reports	8- XV ..
KF Centering Ring	8- 1 ..
KF Centering Ring with O'Ring	8- 2 ..
KF Centering Ring, with Outer Ring & O'Ring	8- 3 ..
KF Centering Ring Adaptor, O'Ring	8- 4 ..
KF Meshed Centering Ring	8- 5 ..
KF Overpressure Ring	8- 6 ..
ISO Centering Ring	8- 7 ..
ISO Centering Ring with O'Ring	8- 9 ..
ISO Outer Ring Centering Ring, O'Ring	8- 13 ..



General Information

VACUUM SOLUTION 2009

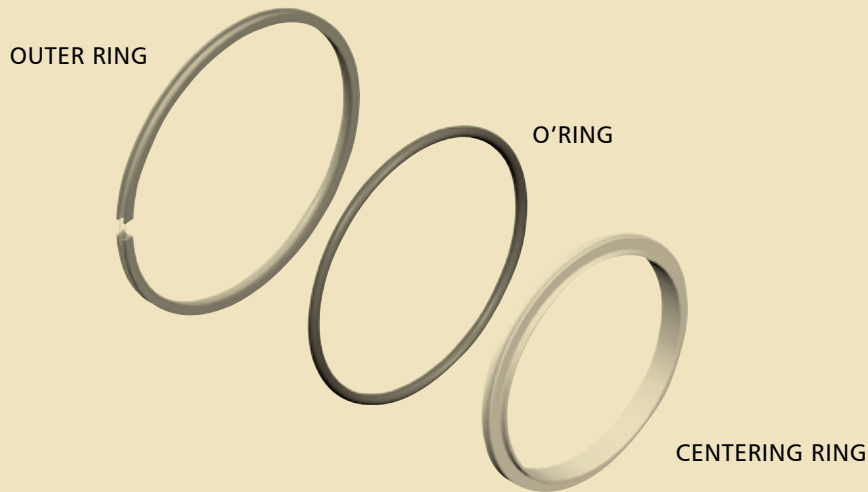

Features

- Viton O'ring bakeable to 200°C intermittently, sustained use to 150°C.
- Vacuum seal of KF-series: O'ring compression by uniform pressure application around the 15° outer flange surface.
- The vacuum seal of ISO-series is made by compressing the O'ring between the mating flanges. This done by alternately wrench-tightening opposing pairs of clamps or bolts until the first metal-to-metal contact is made between the inner surfaces of the flanges and the spacing lips of the centering ring.

Specifications

- Centering Ring : 304 S.S. (Other material available upon request)
- O'ring : Viton (Other material available upon request)
- Outer Ring : Aluminum
- Mesh : 304 S.S.
- Temperature Range : 150°C (Viton) 80°C (NBR)
- **Larger or special size available upon request**

Applications

- The O'ring is considered a universal sealing device.
Used as static, dynamic, radial or face seals.
- Vacuum seal.

Description

- Viton O'ring are normally used in vacuum service in place of NBR and silicone rubber.
- Viton has a low porosity to most gases (except helium) and withstands high temperature (up to 200°C) for short period. NBR O'ring are low cost, but their maximum operating temperature (approx. 100°C) makes them unacceptable for many vacuum applications. Silicone O'rings can withstand temperatures of 250°C for short periods, but silicone tends to harden to prolonged high temperature service, sticking to the metal surfaces and making the O'ring difficult to replaced. Silicone is also very porous to helium.

Comparison of Properties of Generic Elastomers

ELASTOMER TYPE (Polymer)											
PROPERTIES	FFKM	FXM	FKM	EPDM	NBR	ECO	HNBR	CR	AU	SI	FSI
ABRASION RESISTANCE	×	□	□	□	□	□	□	□	◎	×	×
ACID RESISTANCE	◎	◎	◎	□	△	△	◎	△	×	△	△
CHEMICAL RESISTANCE	◎	◎	◎	◎	△	□	△	△	△	□	◎
COLD RESISTANCE	×	×	×	□	□	□	□	△	□	◎	□
ELECTRICAL RESISTANCE	◎	△	△	□	△	△	△	△	△	◎	◎
FLAME RESISTANCE	◎	◎	◎	×	×	△	×	□	×	△	□
HEAT RESISTANCE	◎	◎	◎	◎	□	△	◎	□	◎	◎	◎
IMPERMEABILITY	□	□	□	□	□	□	□	□	□	×	×
OIL RESISTANCE	◎	△	◎	×	◎	◎	◎	△	□	×	□
OZONE RESISTANCE	◎	◎	◎	◎	×	◎	□	□	◎	◎	◎
SET RESISTANCE	□	□	□	□	□	×	□	△	△	□	□
TEAR RESISTANCE	△	△	△	□	△	□	△	△	□	×	×
TENSILE RESISTANCE	△	□	□	□	□	□	◎	□	◎	×	△
WATER/STEAM RESISTANCE	□	□	△	◎	△	△	◎	△	×	△	△
WEATER RESISTANCE	◎	◎	◎	◎	△	◎	□	◎	◎	◎	◎
NOTE	FFKM	CHEMRAZ® Perfluoroelastomer									
	FXM	FLUORAZ® TFE/Propylene									
	FKM	FLUROELASTOMER VF2/HPF (Viton®)									
	EPDM	ETHYLENE PROPYLENE									
	NBR	NITRILE									
	ECO	EPICHLOROHYDRIN									
	HNBR	HYDROGENATED NITRILE									
	CR	NEOPRENE									
	AU	POLYURETHANE									
	SI	SILICONE									
FSI	FLUROSILICONE										
× -Poor △ -Fair □ -Good ◎ -Excellent											

Temperature Range of Generic Elastomers

ELASTOMER	TEMPERATURE RANGE
EPICHLOROHYDRIN	- 20°C ~ 120°C
URETHANE	- 40°C ~ 93°C
NEOPRENE	- 54°C ~ 121°C
NITRILE	- 54°C ~ 121°C
HYDROGENATED NITRILE	- 5°C ~ 150°C
ETHYLENE PROPYLENE	- 54°C ~ 150°C
FLUOROSILICONE	- 40°C ~ 205°C
SILICONE	- 114°C ~ 232°C
FKM FLUOROCARBON	- 5°C ~ 204°C
FLUORAZ FLUOROCARBON	0°C ~ 260°C
CHEMRAZ PERFLUOROELASTOMER	- 25°C ~ 260°C

Polyurethane (AU)

- is a very tough, abrasion and wear-resistant elastoplastic material well suited for use as a hydraulic rod or piston seal in heavy duty applications such as construction and lift equipment. Most polyurethane compounds have a service temperature range from -40°C to +93°C.

Neoprene (CR)

- is a good general purpose polymer with a wide temperature range from -54°C to +121°C. Neoprene exhibits moderate resistance to a broad range of fluids. These attributes account for its wide use as a commercial seal material.

Nitrile (NBR)

- is a popular polymer with excellent resistance to petroleum-based fluids, a good balance of physical properties and a wide temperature range from -54°C to +121°C. Nitrile is the most widely used polymer in the seal industry today, being the base polymer for most military rubber specifications for fuel and oil-resistant MS and AN materials.

Hydrogenated Nitrile (HNBR)

- is a newer polymer type similar to nitrile with improved high-temperature capabilities. Also known as HSN (highly saturated nitrile), HNBR is capable of resisting temperatures up to +150°C with excellent resistance to petroleum-based fluid. Available in a variety of automotive rubber specification grades.

Ethylene Propylene (EPDM)

- is widely specified as a seal material due to its excellent resistance to Skydrol and other phosphate ester based hydraulic fluids. Ethylene propylene has a temperature range from 54°C to +150°C and is suitable for steam service to +204°C. EPDM materials are widely used to seal automotive brake fluids and in aircraft hydraulic systems.

Silicone (SI)

- as a glass this polymer exhibits exceptional heat and compression set resistance but relatively poor tensile strength, tear and abrasion resistance. Silicones have the advantage of being useful in wide temperature extremes. The maximum recommended temperature for continuous service is +232°C. Silicone is recommended for use in dry heat, high-aniline point oils and chlorinated di-phenyls.

Fluorocarbon (FKM)

- is the second most popular seal material after nitrile. Fluorocarbon polymers have wide-spectrum chemical resistance and a very broad temperature range from -29°C to +204°C. Properly formulated, some fluorocarbon materials have been known to seal temperatures as high as +316°C for short periods. Some fluorocarbon compounds can be used in low temperature static sealing applications to -54°C. FKM is widely used in aircraft, aerospace, automotive and other applications requiring maximum resistance to deterioration by environment and/or fluids.

Perfluoroelastomer (FFKM)

- is a new class of seal material combining the chemical resistance of PTFE with the elastic properties of fluorocarbon. The materials are an excellent choice for use in high-heat applications where harsh chemical environments are present, as in semiconductor processing equipment. FFKM has a temperature range from -25°C to +260°C.

Polyacrylate (ACM)

- has outstanding resistance to petroleum-based fuels and oils. In addition, this material has good resistance to oxidation, ozone and sunlight, with the ability to resist flex cracking. The temperature range of polyacrylate materials is from -18°C to +150°C. ACM is widely used in the automotive industry for automatic transmission and power steering service.

Butyl (IIR)

- prior to the introduction of ethylene, butyl polymers were used to seal phosphate ester type hydraulic fluids. Currently butyl finds its widest sealing application in vacuum systems because of its very low gas permeation rates. The temperature range of butyl is -54°C to $+107^{\circ}\text{C}$.

Fluorosilicone (FMVQ)

- combines the excellent temperature range of silicone with good resistance to petroleum-based fuels and lubricants. Currently, the primary use of fluorosilicone materials is for seals in aircraft fuel systems at temperatures up to $+177^{\circ}\text{C}$ and in applications where high heat environments are combined with potential exposure to petroleum oils and/or hydrocarbon fuels. High-strength fluorosilicone materials with better wear resistance have been developed, and some of these also exhibit much improved resistance to compression set.

Polytetrafluoroethylene (PTFE)

- is a very stable polymer with extremely good resistance to almost all known chemicals as well as a very wide temperature range from -268°C to over $+288^{\circ}\text{C}$. PTFE may be fabricated in its pure state or blended with various fillers to produce a material better suited for a particular application. PTFE has very low friction and is widely used for piston seals and other applications such as valve stem seals where resistance to temperature extremes and harsh chemicals is required.

PEEK

- is an acronym for polyetheretherketone, a high-temperature-resistant plastic used for back-ups and other sealing components where extrusion resistance, high-temperature capability and a broad resistance to chemical environments is needed. Available in unmodified or glass-fill formulations, PEEK has a long-term service temperature capability of $+232^{\circ}\text{C}$.

Nylon

- is a generic name for a well-known family of plastics used widely in the sealing industry as anti-extrusion devices. Nylon is resistant to a variety of petroleum and phosphate ester hydraulic fluids. Nylon's temperature range is -55°C to $+120^{\circ}\text{C}$.

Relation Between O'ring Wire Diameter & Inside Diameter

AS568 (001~475)

Wire diameter of O'Ring(mm)

VACUUM SOLUTION 2009

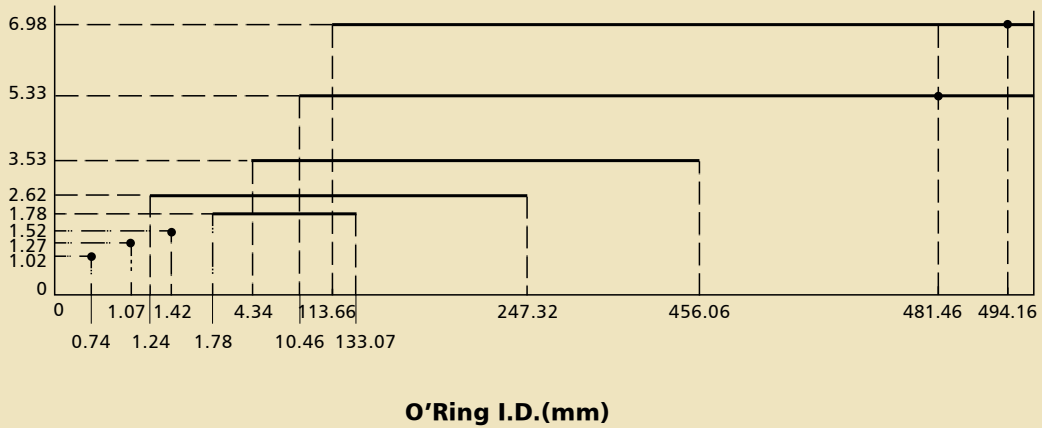

AS568 (901~932)

Wire diameter of O'Ring(mm)

VACUUM SOLUTION 2009

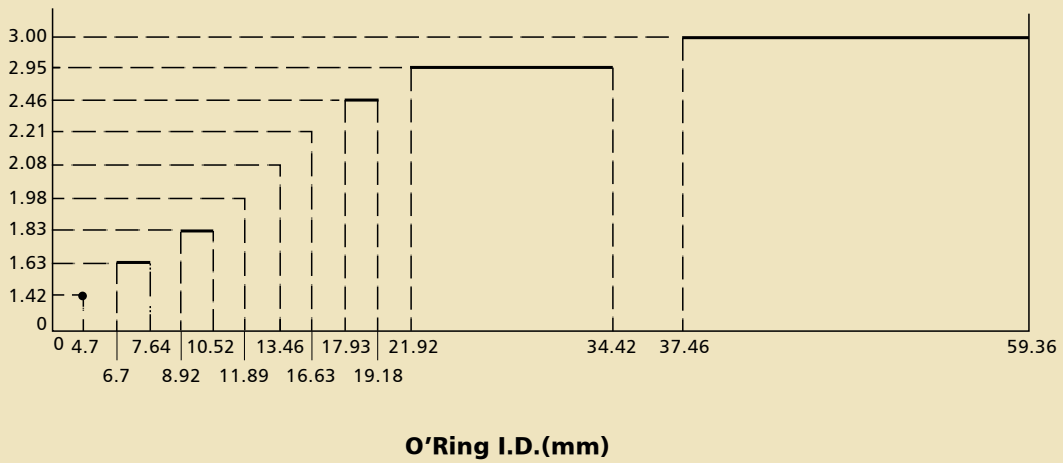

AS568 DASH Numbers

By Cross Section & Internal Diameter

ID	1/16	3/32	1/8	3/16	1/4	ID	1/16	3/32	1/8	3/16	1/4
1/32	001 *					2-5/16		141			
3/64	002**					2-3/8	036	142	229	332	
1/16	003	102				2-7/16		143			
5/16	004					2-1/2	037	144	230	333	
3/32	005	103				2-9/16		145			
1/8	006	104				2-3/8	038	146	231	334	
5/32	007	105				2-11/16		147			
3/16	008	106	201			2-1/4	039	149	232	335	
7/32	009	107				2-13/16		149			
1/4	010	108	202			2-7/8	040	150	233	336	
5/16	011	109	203			3	041	151	234	337	
3/8	012	110	204			3-1/8			235	338	
7/16	013	111	205	309		3-1/4	042	152	236	339	
1/2	014	112	206	310		3-3/8			237	340	
9/16	015	113	207	311		3-1/2	043	153	238	341	
5/8	016	114	208	312		3-5/8			239	342	
11/16	017	115	209	313		3-3/4	044	154	240	343	
3/4	018	116	210	314		3-7/8			241	344	
13/16	019	117	211	315		4	045	155	242	345	
7/8	020	118	212	316		4-1/8			243	346	
15/16	021	119	213	317		4-1/4	046	156	244	347	
1	022	120	214	318		4-3/8			245	348	
1-1/16	023	121	215	319		4-1/2	047	157	246	349	425
1-1/8	024	122	216	320		4-5/8			247	350	426
1-3/16	025	123	217	321		4-3/4	048	158	248	351	427
1-1/4	026	124	218	322		4-7/8			249	352	428
1-5/16	027	125	219	323		5	049	159	250	353	429
1-3/8	028	126	220	324		5-1/8			251	354	430
1-7/16		127	221			5-1/4	050	160	252	355	431
1-1/2	029	128	222	325		5-3/8			253	356	432
1-9/16		129				5-1/2		161	254	357	433
1-5/8	030	130	223	326		5-5/8			255	358	434
1-11/16		131				5-3/4		162	256	359	435
1-3/4	031	132	224	327		5-7/8			257	360	436
1-13/16		133				6		163	258	361	437
1-7/8	032	134	225	328		6-1/4		164	259	362	438
1-15/16		135				6-1/2		165	260	363	439
2	033	136	226	329		6-3/4		166	261	364	440
2-1/16		137				7		167	262	365	441
2-1/8	034	138	227	330		7-1/4		168	263	366	442
2-3/19		139				7-1/2		169	264	367	443
2-1/4	035	140	228	331		7-3/4		170	265	368	444

By Cross Section & Internal Diameter

ID	1/16	3/32	1/8	3/16	1/4
8		171	266	369	445
8-1/4		172	267		
8-1/2		173	268	370	446
8-3/4		174	269	371	
9		175	270	372	447
9-1/4		176	271	373	
9-1/2		177	272	374	448
9-3/4		178	273	375	
10			274	376	449
10-1/4				377	
10-1/2			275	378	450
10-3/4					
11			276	379	451
11-1/4					
11-1/2			277	380	452
11-3/4					
12			278	381	453
12-1/2					454
13			279	382	455
13-1/2					456
14			280	383	457
14-1/2					458
15			281	384	459
15-1/2					460
16			282	385	461
16-1/2					462
17			283	386	463
17-1/2					464
18			284	387	465
18-1/2					466
19				388	467
19-1/2					468
20				389	469
21				390	470
22				391	471
23				392	472
24				393	473
25				394	474
26				395	475

* AS568-001 Nominal cross section = 1/32

** AS568-002 Nominal cross section = 3/64

JIS B2401 O-Ring Sizes**P series**

Size	ID	CS	Size	ID	CS
P3	2.80 ±0.14	1.90 ±0.08	P39	38.70 ±0.37	3.50 ±0.10
P4	3.80 ±0.14	1.90 ±0.08	P40	39.70 ±0.38	3.50 ±0.10
P5	4.80 ±0.15	1.90 ±0.08	P41	40.70 ±0.39	3.50 ±0.10
P6	5.80 ±0.15	1.90 ±0.08	P42	41.70 ±0.41	3.50 ±0.10
P7	6.80 ±0.16	1.90 ±0.08	P44	43.70 ±0.41	3.50 ±0.10
P8	7.80 ±0.16	1.90 ±0.08	P45	44.70 ±0.42	3.50 ±0.10
P9	8.80 ±0.17	1.90 ±0.08	P46	45.70 ±0.44	3.50 ±0.10
P10	9.80 ±0.17	1.90 ±0.08	P48	47.70 ±0.45	3.50 ±0.10
P10A	9.80 ±0.17	2.40 ±0.09	P49	48.70 ±0.45	3.50 ±0.10
P11	10.80 ±0.18	2.40 ±0.09	P50	49.70 ±0.45	3.50 ±0.10
P11.2	11.00 ±0.18	2.40 ±0.09	P48A	47.60 ±0.45	5.70 ±0.13
P12	11.80 ±0.19	2.40 ±0.09	P50A	49.60 ±0.45	5.70 ±0.13
P12.5	12.30 ±0.19	2.40 ±0.09	P52	51.60 ±0.47	5.70 ±0.13
P14	13.80 ±0.19	2.40 ±0.09	P53	52.60 ±0.48	5.70 ±0.13
P15	14.80 ±0.20	2.40 ±0.09	P55	54.60 ±0.49	5.70 ±0.13
P16	15.80 ±0.20	2.40 ±0.09	P56	55.60 ±0.50	5.70 ±0.13
P18	17.80 ±0.21	2.40 ±0.09	P58	57.60 ±0.52	5.70 ±0.13
P20	19.80 ±0.22	2.40 ±0.09	P60	59.60 ±0.53	5.70 ±0.13
P21	20.80 ±0.23	2.40 ±0.09	P62	61.60 ±0.55	5.70 ±0.13
P22	21.80 ±0.24	2.40 ±0.09	P63	62.60 ±0.56	5.70 ±0.13
P22A	21.70 ±0.24	3.50 ±0.10	P65	64.60 ±0.57	5.70 ±0.13
P22.4	22.10 ±0.24	3.50 ±0.10	P67	66.60 ±0.59	5.70 ±0.13
P24	23.70 ±0.24	3.50 ±0.10	P70	69.60 ±0.61	5.70 ±0.13
P25	24.70 ±0.25	3.50 ±0.10	P71	70.60 ±0.62	5.70 ±0.13
P25.5	25.20 ±0.25	3.50 ±0.10	P75	74.60 ±0.65	5.70 ±0.13
P26	25.70 ±0.26	3.50 ±0.10	P80	79.60 ±0.69	5.70 ±0.13
P28	27.70 ±0.28	3.50 ±0.10	P85	84.60 ±0.73	5.70 ±0.13
P29	28.70 ±0.29	3.50 ±0.10	P90	89.60 ±0.77	5.70 ±0.13
P29.5	29.20 ±0.29	3.50 ±0.10	P95	94.60 ±0.81	5.70 ±0.13
P30	29.70 ±0.29	3.50 ±0.10	P100	99.60 ±0.84	5.70 ±0.13
P31	30.70 ±0.30	3.50 ±0.10	P102	101.60 ±0.85	5.70 ±0.13
P31.5	32.10 ±0.31	3.50 ±0.10	P105	104.60 ±0.87	5.70 ±0.13
P32	31.70 ±0.31	3.50 ±0.10	P110	109.60 ±0.91	5.70 ±0.13
P34	33.70 ±0.33	3.50 ±0.10	P112	111.60 ±0.92	5.70 ±0.13
P35	34.70 ±0.34	3.50 ±0.10	P115	114.60 ±0.94	5.70 ±0.13
P35.5	35.20 ±0.34	3.50 ±0.10	P120	119.60 ±0.98	5.70 ±0.13
P36	35.70 ±0.37	3.50 ±0.10	P125	124.60 ±1.01	5.70 ±0.13
P38	37.70 ±0.37	3.50 ±0.10	P130	129.60 ±1.05	5.70 ±0.13

Size	ID	CS	Size	ID	CS
P132	131.60 ±1.06	5.70 ±0.13	P320	319.50 ±2.33	8.40 ±0.15
P135	134.60 ±1.09	5.70 ±0.13	P335	334.50 ±2.42	8.40 ±0.15
P140	139.60 ±1.12	5.70 ±0.13	P340	339.50 ±2.45	8.40 ±0.15
P145	144.60 ±1.16	5.70 ±0.13	P355	354.50 ±2.54	8.40 ±0.15
P150	149.60 ±1.19	5.70 ±0.13	P360	359.50 ±2.57	8.40 ±0.15
P150A	149.50 ±1.19	8.40 ±0.15	P375	374.50 ±2.67	8.40 ±0.15
P155	154.50 ±1.23	8.40 ±0.15	P385	384.50 ±2.73	8.40 ±0.15
P160	159.50 ±1.26	8.40 ±0.15	P400	399.50 ±2.82	8.40 ±0.15
P165	164.50 ±1.30	8.40 ±0.15			
P170	169.50 ±1.33	8.40 ±0.15			
P175	174.50 ±1.37	8.40 ±0.15			
P180	179.50 ±1.40	8.40 ±0.15			
P185	184.50 ±1.44	8.40 ±0.15			
P190	189.50 ±1.48	8.40 ±0.15			
P195	194.50 ±1.51	8.40 ±0.15			
P200	199.50 ±1.55	8.40 ±0.15			
P205	204.50 ±1.58	8.40 ±0.15			
P209	208.50 ±1.61	8.40 ±0.15			
P210	209.50 ±1.62	8.40 ±0.15			
P215	214.50 ±1.65	8.40 ±0.15			
P220	219.50 ±1.68	8.40 ±0.15			
P225	224.50 ±1.71	8.40 ±0.15			
P230	229.50 ±1.75	8.40 ±0.15			
P235	234.50 ±1.78	8.40 ±0.15			
P240	239.50 ±1.81	8.40 ±0.15			
P245	244.50 ±1.84	8.40 ±0.15			
P250	249.50 ±1.88	8.40 ±0.15			
P255	254.50 ±1.91	8.40 ±0.15			
P260	259.50 ±1.94	8.40 ±0.15			
P265	264.50 ±1.97	8.40 ±0.15			
P270	269.50 ±2.01	8.40 ±0.15			
P275	274.50 ±2.04	8.40 ±0.15			
P280	279.50 ±2.07	8.40 ±0.15			
P285	284.50 ±2.10	8.40 ±0.15			
P290	289.50 ±2.14	8.40 ±0.15			
P295	294.50 ±2.17	8.40 ±0.15			
P300	299.50 ±2.20	8.40 ±0.15			
P315	314.50 ±2.30	8.40 ±0.15			

JIS B2401 O-Ring Sizes**G series**

Size	ID	CS	Size	ID	CS
G25	24.40 ±0.25	3.10 ±0.10	G215	214.30 ±1.64	5.70 ±0.13
G30	29.40 ±0.29	3.10 ±0.10	G220	219.30 ±1.68	5.70 ±0.13
G35	34.40 ±0.33	3.10 ±0.10	G225	224.30 ±1.71	5.70 ±0.13
G40	39.40 ±0.37	3.10 ±0.10	G230	229.30 ±1.73	5.70 ±0.13
G45	44.40 ±0.41	3.10 ±0.10	G235	234.30 ±1.77	5.70 ±0.13
G50	49.40 ±0.45	3.10 ±0.10	G240	239.30 ±1.81	5.70 ±0.13
G55	54.40 ±0.49	3.10 ±0.10	G245	244.30 ±1.84	5.70 ±0.13
G60	59.40 ±0.53	3.10 ±0.10	G250	249.30 ±1.88	5.70 ±0.13
G65	64.40 ±0.57	3.10 ±0.10	G255	254.30 ±1.91	5.70 ±0.13
G70	69.40 ±0.61	3.10 ±0.10	G260	259.30 ±1.94	5.70 ±0.13
G75	74.40 ±0.65	3.10 ±0.10	G265	264.30 ±1.97	5.70 ±0.13
G80	79.40 ±0.69	3.10 ±0.10	G270	269.30 ±2.01	5.70 ±0.13
G85	84.40 ±0.73	3.10 ±0.10	G275	274.30 ±2.04	5.70 ±0.13
G90	89.40 ±0.77	3.10 ±0.10	G280	279.30 ±2.07	5.70 ±0.13
G95	94.40 ±0.81	3.10 ±0.10	G285	284.30 ±2.10	5.70 ±0.13
G100	99.40 ±0.85	3.10 ±0.10	G290	289.30 ±2.14	5.70 ±0.13
G105	104.40 ±0.87	3.10 ±0.10	G295	294.30 ±2.17	5.70 ±0.13
G110	109.40 ±0.91	3.10 ±0.10	G300	299.30 ±2.20	5.70 ±0.13
G115	114.40 ±0.94	3.10 ±0.10	G305	304.30 ±2.24	5.70 ±0.13
G120	119.40 ±0.98	3.10 ±0.10	G310	309.30 ±2.27	5.70 ±0.13
G125	124.40 ±1.01	3.10 ±0.10	G315	314.30 ±2.30	5.70 ±0.13
G130	129.40 ±1.05	3.10 ±0.10	G320	319.30 ±2.33	5.70 ±0.13
G135	134.40 ±1.08	3.10 ±0.10	G325	324.30 ±2.36	5.70 ±0.13
G140	139.40 ±1.12	3.10 ±0.10	G330	329.30 ±2.39	5.70 ±0.13
G145	144.40 ±1.16	3.10 ±0.10	G335	334.30 ±2.42	5.70 ±0.13
G150	149.30 ±1.19	5.70 ±0.13	G340	339.30 ±2.45	5.70 ±0.13
G155	154.30 ±1.23	5.70 ±0.13	G345	344.30 ±2.48	5.70 ±0.13
G160	159.30 ±1.26	5.70 ±0.13	G350	349.30 ±2.51	5.70 ±0.13
G165	164.30 ±1.30	5.70 ±0.13	G355	354.30 ±2.54	5.70 ±0.10
G170	169.30 ±1.33	5.70 ±0.13	G360	359.30 ±2.57	5.70 ±0.10
G175	174.30 ±1.37	5.70 ±0.13	G365	364.30 ±2.60	5.70 ±0.10
G180	179.30 ±1.40	5.70 ±0.13	G370	369.30 ±2.63	5.70 ±0.13
G185	184.30 ±1.44	5.70 ±0.13	G375	374.30 ±2.67	5.70 ±0.13
G190	189.30 ±1.47	5.70 ±0.13	G380	379.30 ±2.70	5.70 ±0.13
G195	194.30 ±1.51	5.70 ±0.13	G385	384.30 ±2.73	5.70 ±0.13
G200	199.30 ±1.55	5.70 ±0.13	G390	389.30 ±2.76	5.70 ±0.13
G205	204.30 ±1.58	5.70 ±0.13	G395	394.30 ±2.79	5.70 ±0.13
G210	209.30 ±1.61	5.70 ±0.13	G400	399.30 ±2.82	5.70 ±0.13

JIS B2401 O-Ring Sizes

S series

Size	ID	CS	Size	ID	CS
S3	2.5 ±0.15	1.5 ±0.10	S50	49.5 ±0.25	2.0 ±0.10
S4	3.5 ±0.15	1.5 ±0.10	S53	52.5 ±0.25	2.0 ±0.10
S5	4.5 ±0.15	1.5 ±0.10	S55	54.5 ±0.25	2.0 ±0.10
S6	5.5 ±0.15	1.5 ±0.10	S56	55.5 ±0.25	2.0 ±0.10
S7	6.5 ±0.15	1.5 ±0.10	S60	59.5 ±0.25	2.0 ±0.10
S8	7.5 ±0.15	1.5 ±0.10	S63	62.5 ±0.25	2.0 ±0.10
S9	8.5 ±0.15	1.5 ±0.10	S65	64.5 ±0.25	2.0 ±0.10
S10	9.5 ±0.15	1.5 ±0.10	S67	66.5 ±0.25	2.0 ±0.10
S11.2	10.7 ±0.15	1.5 ±0.10	S70	69.5 ±0.25	2.0 ±0.10
S12	11.5 ±0.15	1.5 ±0.10	S71	70.5 ±0.4	2.0 ±0.10
S12.5	12.0 ±0.15	1.5 ±0.10	S75	74.5 ±0.4	2.0 ±0.10
S14	13.5 ±0.15	1.5 ±0.10	S80	79.5 ±0.4	2.0 ±0.10
S15	14.5 ±0.15	1.5 ±0.10	S85	84.5 ±0.4	2.0 ±0.10
S16	15.5 ±0.15	1.5 ±0.10	S90	89.5 ±0.4	2.0 ±0.10
S18	17.5 ±0.15	1.5 ±0.10	S95	94.5 ±0.4	2.0 ±0.10
S20	19.5 ±0.15	1.5 ±0.10	S100	99.5 ±0.4	2.0 ±0.10
S22	21.5 ±0.15	1.5 ±0.10	S105	104.5 ±0.4	2.0 ±0.10
S22.4	21.9 ±0.15	2.0 ±0.10	S110	109.5 ±0.4	2.0 ±0.10
S24	23.5 ±0.15	2.0 ±0.10	S112	111.5 ±0.4	2.0 ±0.10
S25	24.5 ±0.15	2.0 ±0.10	S115	114.5 ±0.4	2.0 ±0.10
S26	25.5 ±0.15	2.0 ±0.10	S120	119.5 ±0.4	2.0 ±0.10
S28	27.5 ±0.15	2.0 ±0.10	S125	124.5 ±0.4	2.0 ±0.10
S29	28.5 ±0.15	2.0 ±0.10	S130	129.5 ±0.6	2.0 ±0.10
S30	29.5 ±0.15	2.0 ±0.10	S132	131.5 ±0.6	2.0 ±0.10
S31.5	31.0 ±0.15	2.0 ±0.10	S135	134.5 ±0.6	2.0 ±0.10
S32	31.5 ±0.15	2.0 ±0.10	S140	139.5 ±0.6	2.0 ±0.10
S34	33.5 ±0.15	2.0 ±0.10	S145	144.5 ±0.6	2.0 ±0.10
S35	34.5 ±0.15	2.0 ±0.10	S150	149.5 ±0.6	2.0 ±0.10
S35.5	35.0 ±0.15	2.0 ±0.10			
S36	35.5 ±0.15	2.0 ±0.10			
S38	37.5 ±0.15	2.0 ±0.10			
S39	38.5 ±0.15	2.0 ±0.10			
S40	39.5 ±0.15	2.0 ±0.10			
S42	41.5 ±0.25	2.0 ±0.10			
S44	43.5 ±0.25	2.0 ±0.10			
S45	44.5 ±0.25	2.0 ±0.10			
S46	45.5 ±0.25	2.0 ±0.10			
S48	47.5 ±0.25	2.0 ±0.10			

JIS B2401 O-Ring Sizes**V series**

Size	ID	CS
V15	14.5 ±0.20	4.0 ±0.10
V24	23.5 ±0.24	4.0 ±0.10
V34	33.5 ±0.33	4.0 ±0.10
V40	39.5 ±0.37	4.0 ±0.10
V55	54.5 ±0.49	4.0 ±0.10
V70	69.0 ±0.61	4.0 ±0.10
V85	84.0 ±0.72	4.0 ±0.10
V100	99.0 ±0.83	4.0 ±0.10
V120	119.0 ±0.97	4.0 ±0.10
V150	148.5 ±1.18	4.0 ±0.10
V175	173.0 ±1.36	4.0 ±0.10
V225	222.5 ±1.70	6.0 ±0.15
V275	272.0 ±2.02	6.0 ±0.15
V325	321.5 ±2.34	6.0 ±0.15
V380	376.0 ±2.68	6.0 ±0.15
V430	425.5 ±2.99	6.0 ±0.15
V480	475.0 ±3.30	10.0 ±0.30
V530	524.5 ±3.60	10.0 ±0.30
V585	579.0 ±3.92	10.0 ±0.30
V640	633.5 ±4.24	10.0 ±0.30
V690	683.0 ±4.54	10.0 ±0.30
V740	732.5 ±4.83	10.0 ±0.30
V790	782.0 ±5.12	10.0 ±0.30
V845	836.5 ±5.44	10.0 ±0.30
V950	940.5 ±6.06	10.0 ±0.30
V1055	1044.0 ±6.67	10.0 ±0.30

Durometer Chart

- The hardness of rubber compounds is measured by the Shore A durometer; the higher the durometer number, the harder the compound. 70-durometer hardness should be used wherever possible as it offers the best combination of properties for most o-ring applications. Softer compounds stretch easier and seal better on rough surfaces. Harder compounds offer greater abrasion resistance and resistance to extrusion. Extrusion must always be considered when high pressures are used. The proper hardness may be selected from this chart by matching the fluid pressure with maximum extrusion gap.

VACUUM SOLUTION 2009

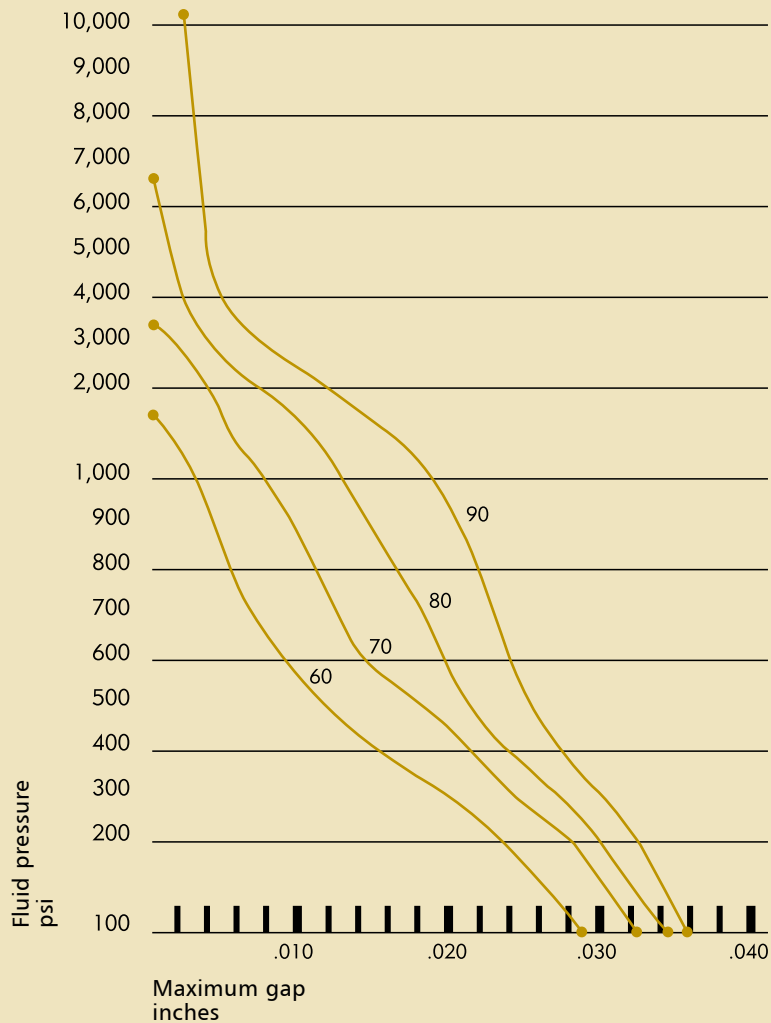



KF Centering Ring

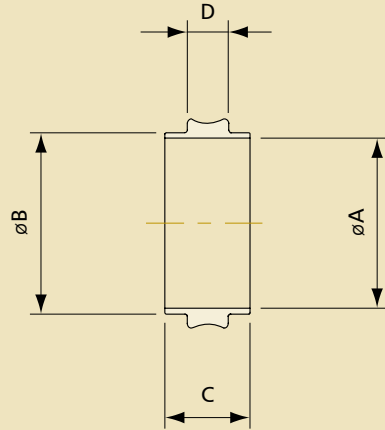
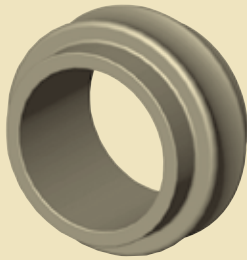

Model No.	Material	A	B	C	D	Parts No.
KF10CRS	304 S.S.	10	12	8	3.9	180003410
KF16CRS	304 S.S.	16	17	8	3.9	180005410
KF25CRS	304 S.S.	25	26	8	3.9	180006410
KF40CRS	304 S.S.	40	41	8	3.9	180008410
KF50CRS	304 S.S.	50	52	8	3.9	180009410
KF10CRA	Al	10	12	8	3.9	180003110
KF16CRA	Al	16	17	8	3.9	180005110
KF25CRA	Al	25	26	8	3.9	180006110
KF40CRA	Al	40	41	8	3.9	180008110
KF50CRA	Al	50	52	8	3.9	180009110

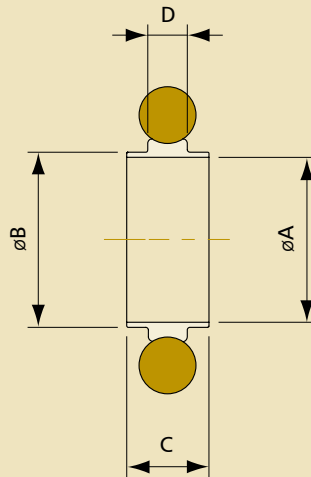
KF Centering Ring with O'Ring

Model No.	Material	O'Ring	A	B	C	D	Parts No.	
	C/R	O'Ring	Size					
KF10CRVS	304 S.S.	Viton	AS-311	10	12	8	3.9	180103411
KF16CRVS	304 S.S.	Viton	AS-314	16	17	8	3.9	180105411
KF25CRVS	304 S.S.	Viton	AS-320	25	26	8	3.9	180106411
KF40CRVS	304 S.S.	Viton	AS-326	40	41	8	3.9	180108411
KF50CRVS	304 S.S.	Viton	AS-330	50	52	8	3.9	180109411
KF10CRVA	Al	Viton	AS-311	10	12	8	3.9	180103111
KF16CRVA	Al	Viton	AS-314	16	17	8	3.9	180105111
KF25CRVA	Al	Viton	AS-320	25	26	8	3.9	180106111
KF40CRVA	Al	Viton	AS-326	40	41	8	3.9	180108111
KF50CRVA	Al	Viton	AS-330	50	52	8	3.9	180109111
KF10CRNS	304 S.S.	NBR	AS-311	10	12	8	3.9	180303412
KF16CRNS	304 S.S.	NBR	AS-314	16	17	8	3.9	180305412
KF25CRNS	304 S.S.	NBR	AS-320	25	26	8	3.9	180306412
KF40CRNS	304 S.S.	NBR	AS-326	40	41	8	3.9	180308412
KF50CRNS	304 S.S.	NBR	AS-330	50	52	8	3.9	180309412
KF10CRNA	Al	NBR	AS-311	10	12	8	3.9	180303112
KF16CRNA	Al	NBR	AS-314	16	17	8	3.9	180305112
KF25CRNA	Al	NBR	AS-320	25	26	8	3.9	180306112
KF40CRNA	Al	NBR	AS-326	40	41	8	3.9	180308112
KF50CRNA	Al	NBR	AS-330	50	52	8	3.9	180309112

O'Ring color for NBR material is black, brown is available upon request
O'Ring color for Viton material is brown, black is available upon request

KF Centering Ring, with Outer Ring & O'Ring

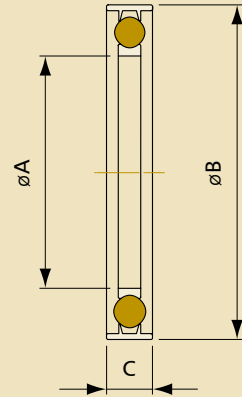

Model No.	Material		O'Ring	A	B	C	Parts No.	
	O/R	C/R	O'Ring	Size				
KF16OCRVS	Al	304 S.S.	Viton	5018	16	32.5	8	181105421
KF25OCRVS	Al	304 S.S.	Viton	5028	25	42.5	8	181106421
KF40OCRVS	Al	304 S.S.	Viton	5042	40	57.5	8	181108421
KF50OCRVS	Al	304 S.S.	Viton	AS-330	50	77.5	8	181109421
KF16OCR-316	Al	316 S.S.	Viton	5018	16	32.5	8	181105621
KF25OCR-316	Al	316 S.S.	Viton	5028	25	42.5	8	181106621
KF40OCR-316	Al	316 S.S.	Viton	5042	40	57.5	8	181108621
KF50OCR-316	Al	316 S.S.	Viton	AS-330	50	77.5	8	181109621

O'Ring's color is brown, black is available upon request

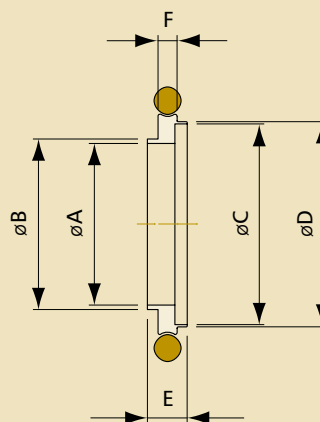
KF Centering Ring Adaptor, O'Ring

Model No.	Material	O'Ring	A	B	C	D	E	F	Parts No.	
	C/R	O'Ring	Size							
KF10CR16VS	304 S.S.	Viton	AS-314	10	12	16	17	8	3.9	19011A411
KF20CR25VS	304 S.S.	Viton	AS-320	20	22	25	26	8	3.9	19011B411
KF32CR40VS	304 S.S.	Viton	AS-326	32	34	40	41	8	3.9	19011C411
KF10CR16VA	Al	Viton	AS-314	10	12	16	17	8	3.9	19011A111
KF20CR25VA	Al	Viton	AS-320	20	22	25	26	8	3.9	19011B111
KF32CR40VA	Al	Viton	AS-326	32	34	40	41	8	3.9	19011C111
KF10CR16NS	304 S.S.	NBR	AS-314	10	12	16	17	8	3.9	19031A412
KF20CR25NS	304 S.S.	NBR	AS-320	20	22	25	26	8	3.9	19031B412
KF32CR40NS	304 S.S.	NBR	AS-326	32	34	40	41	8	3.9	19031C412
KF10CR16NA	Al	NBR	AS-314	10	12	16	17	8	3.9	19031A112
KF20CR25NA	Al	NBR	AS-320	20	22	25	26	8	3.9	19031B112
KF32CR40NA	Al	NBR	AS-326	32	34	40	41	8	3.9	19031C112

O'Ring color for NBR material is black, brown is available upon request
O'Ring color for Viton material is brown, black is available upon request

KF Meshed Centering Ring

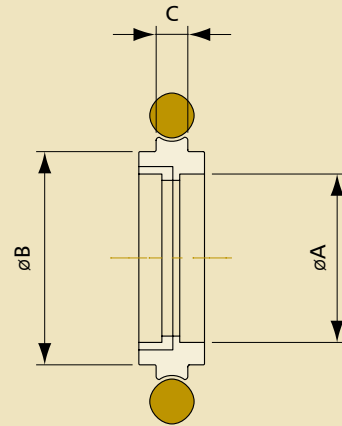
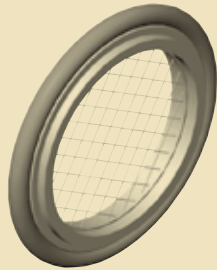

Model No.	Material C/R	O'Ring O'Ring	O'Ring Size	Mesh/In ²	A	B	C	Parts No.
KF16M3CRVS	304 S.S.	Viton	AS-314	900	12	17	3.9	183105411
KF25M3CRVS	304 S.S.	Viton	AS-320	900	20.5	26	3.9	183106411
KF40M3CRVS	304 S.S.	Viton	AS-326	900	35.8	41	3.9	183108411
KF50M3CRVS	304 S.S.	Viton	AS-330	900	46.3	52	3.9	183109411
KF63M3CRVS	304 S.S.	Viton	AS-337	900	60.5	69.6	3.9	183110411
KF80M3CRVS	304 S.S.	Viton	AS-341	900	73.6	82.6	3.9	183111411
KF100M3CRVS	304 S.S.	Viton	AS-347	900	91.8	101.6	3.9	183112411
KF160M3CRVS	304 S.S.	Viton	AS-362	900	143.5	152.6	3.9	183115411
KF16M3CRNS	304 S.S.	NBR	AS-314	900	12	17	3.9	183305412
KF25M3CRNS	304 S.S.	NBR	AS-320	900	20.5	26	3.9	183306412
KF40M3CRNS	304 S.S.	NBR	AS-326	900	35.8	41	3.9	183308412
KF50M3CRNS	304 S.S.	NBR	AS-330	900	46.3	52	3.9	183309412
KF63M3CRNS	304 S.S.	NBR	AS-337	900	60.5	69.6	3.9	183310412
KF80M3CRNS	304 S.S.	NBR	AS-341	900	73.6	82.6	3.9	183311412
KF100M3CRNS	304 S.S.	NBR	AS-347	900	91.8	101.6	3.9	183312412
KF160M3CRNS	304 S.S.	NBR	AS-362	900	143.5	152.6	3.9	183315412

O'Ring color for NBR material is black, brown is available upon request
 O'Ring color for Viton material is brown, black is available upon request

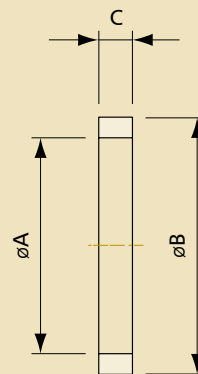
KF Overpressure Ring

Model No.	Material	A	B	C	Parts No.
KF10OPR	304 S.S.	23.5	28	3.7	20000341
KF16OPR	304 S.S.	30.12	31.75	3.7	20000541
KF25OPR	304 S.S.	38.86	40.4	3.7	20000641
KF40OPR	304 S.S.	54	57.15	3.7	20000841
KF50OPR	304 S.S.	66.55	69.85	3.7	20000941
ISO80OPR	304 S.S.	100.2	106	3.9	20001141

ISO Centering Ring

Available Area :Europe

C/R' with a notch

Special sizes available upon request

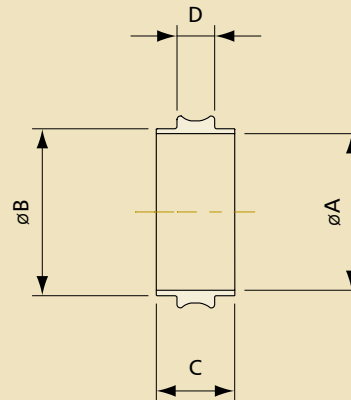

Model No.	Material	A	B	C	D	Parts No.
ISO63CRSE	304 S.S.	68	70	8	3.9	191010420
ISO80CRSE	304 S.S.	81	82.6	8	3.9	191011420
ISO100CRSE	304 S.S.	100	102	8	3.9	191012420
ISO160CRSE	304 S.S.	148	153	8	3.9	191015420
ISO200CRSE	304 S.S.	210	213	8	3.9	191016420
ISO250CRSE	304 S.S.	257.5	261	8	3.9	191017420
ISO320CRSE	304 S.S.	312	318	12	5.6	191019420
ISO400CRSE	304 S.S.	394	400	12	5.6	191021420
ISO500CRSE	304 S.S.	494	501	12	5.6	191023420
ISO63CRAE	Al	68	70	8	3.9	191010120
ISO80CRAE	Al	81	82.6	8	3.9	191011120
ISO100CRAE	Al	100	102	8	3.9	191012120
ISO160CRAE	Al	148	153	8	3.9	191015120
ISO200CRAE	Al	210	213	8	3.9	191016120
ISO250CRAE	Al	257.5	261	8	3.9	191017120
ISO320CRAE	Al	312	318	12	5.6	191019120
ISO400CRAE	Al	394	400	12	5.6	191021120
ISO500CRAE	Al	494	501	12	5.6	191023120

ISO Centering Ring

Available Area :U.S.A

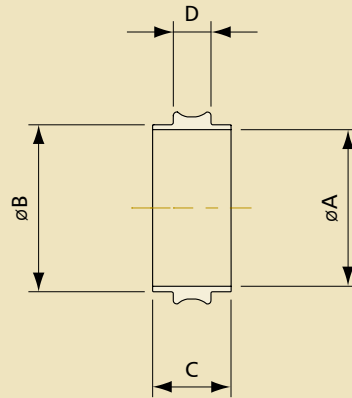

Model No.	Material	A	B	C	D	Parts No.
ISO63CRSA	304 S.S.	67	69.6	8	3.9	191010410
ISO80CRSA	304 S.S.	80	82.6	8	3.9	191011410
ISO100CRSA	304 S.S.	100	101.6	8	3.9	191012410
ISO160CRSA	304 S.S.	150	152.6	8	3.9	191015410
ISO200CRSA	304 S.S.	210	212.6	8	3.9	191016410
ISO250CRSA	304 S.S.	257.5	260.4	8	3.9	191017410
ISO320CRSA	304 S.S.	312	318.3	12	5.6	191019410
ISO400CRSA	304 S.S.	394	399.2	12	5.6	191021410
ISO500CRSA	304 S.S.	494	500.2	12	5.6	191023410
ISO63CRAA	Al	67	69.6	8	3.9	191010110
ISO80CRAA	Al	80	82.6	8	3.9	191011110
ISO100CRAA	Al	100	101.6	8	3.9	191012110
ISO160CRAA	Al	150	152.6	8	3.9	191015110
ISO200CRAA	Al	210	212.6	8	3.9	191016110
ISO250CRAA	Al	257.5	260.4	8	3.9	191017110
ISO320CRAA	Al	312	318.3	12	5.6	191019110
ISO400CRAA	Al	394	399.2	12	5.6	191021110
ISO500CRAA	Al	494	500.2	12	5.6	191023110

ISO Centering Ring with O'Ring

Available Area :Europe

C/R' with a notch

Special sizes available upon request

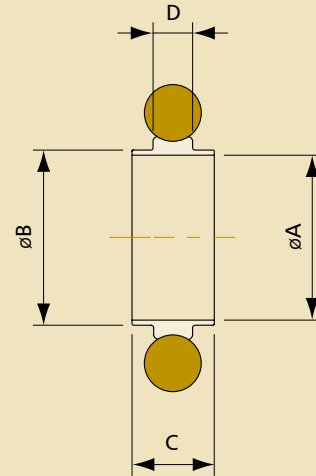

Model No.	Material	O'Ring	A	B	C	D	Parts No.	
	C/R	O'Ring	Size					
ISO63CRVSE	304 S.S.	Viton	AS-337	68	70	8	3.9	191110421
ISO80CRVSE	304 S.S.	Viton	AS-341	81	82.6	8	3.9	191111421
ISO100CRVSE	304 S.S.	Viton	AS-347	100	102	8	3.9	191112421
ISO160CRVSE	304 S.S.	Viton	AS-362	148	153	8	3.9	191115421
ISO200CRVSE	304 S.S.	Viton	AS-371	210	213	8	3.9	191116421
ISO250CRVSE	304 S.S.	Viton	AS-378	257.5	261	8	3.9	191117421
ISO320CRVSE	304 S.S.	Viton	AS-454	312	318	12	5.6	191119421
ISO400CRVSE	304 S.S.	Viton	AS-461	394	400	12	5.6	191121421
ISO500CRVSE	304 S.S.	Viton	AS-469	494	501	12	5.6	191123421
ISO63CRVAE	Al	Viton	AS-337	68	70	8	3.9	191110121
ISO80CRVAE	Al	Viton	AS-341	81	82.6	8	3.9	191111121
ISO100CRVAE	Al	Viton	AS-347	100	102	8	3.9	191112121
ISO160CRVAE	Al	Viton	AS-362	148	153	8	3.9	191115121
ISO200CRVAE	Al	Viton	AS-371	210	213	8	3.9	191116121
ISO250CRVAE	Al	Viton	AS-378	257.5	261	8	3.9	191117121
ISO320CRVAE	Al	Viton	AS-454	312	318	12	5.6	191119121
ISO400CRVAE	Al	Viton	AS-461	394	400	12	5.6	191121121
ISO500CRVAE	Al	Viton	AS-469	494	501	12	5.6	191123121

O'Ring's color is brown, black is available upon request

ISO Centering Ring with O'Ring

Available Area :Europe

C/R' with a notch

Special sizes available upon request

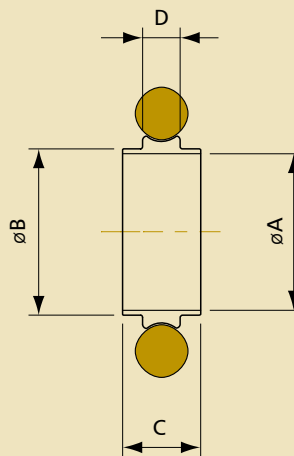

Model No.	Material	O'Ring	A	B	C	D	Parts No.	
	C/R	O'Ring	Size					
ISO63CRNSE	304 S.S.	NBR	AS-337	68	70	8	3.9	191310422
ISO80CRNSE	304 S.S.	NBR	AS-341	81	82.6	8	3.9	191311422
ISO100CRNSE	304 S.S.	NBR	AS-347	100	102	8	3.9	191312422
ISO160CRNSE	304 S.S.	NBR	AS-362	148	153	8	3.9	191315422
ISO200CRNSE	304 S.S.	NBR	AS-371	210	213	8	3.9	191316422
ISO250CRNSE	304 S.S.	NBR	AS-378	257.5	261	8	3.9	191317422
ISO320CRNSE	304 S.S.	NBR	AS-454	312	318	12	5.6	191319422
ISO400CRNSE	304 S.S.	NBR	AS-461	394	400	12	5.6	191321422
ISO500CRNSE	304 S.S.	NBR	AS-469	494	501	12	5.6	191323422
ISO63CRNAE	AI	NBR	AS-337	68	70	8	3.9	191310122
ISO80CRNAE	AI	NBR	AS-341	81	82.6	8	3.9	191311122
ISO100CRNAE	AI	NBR	AS-347	100	102	8	3.9	191312122
ISO160CRNAE	AI	NBR	AS-362	148	153	8	3.9	191315122
ISO200CRNAE	AI	NBR	AS-371	210	213	8	3.9	191316122
ISO250CRNAE	AI	NBR	AS-378	257.5	261	8	3.9	191317122
ISO320CRNAE	AI	NBR	AS-454	312	318	12	5.6	191319122
ISO400CRNAE	AI	NBR	AS-461	394	400	12	5.6	191321122
ISO500CRNAE	AI	NBR	AS-469	494	501	12	5.6	191323122

O'Ring color for NBR material is black, brown is available upon request

ISO Centering Ring with O'Ring

Available Area :U.S.A

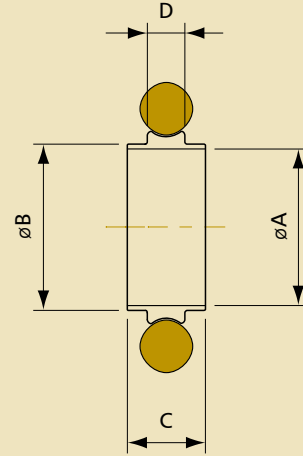

Model No.	Material	O'Ring	A	B	C	D	Parts No.	
	C/R	O'Ring	Size					
ISO63CRVSA	304 S.S.	Viton	AS-337	67	69.6	8	3.9	191110411
ISO80CRVSA	304 S.S.	Viton	AS-341	80	82.6	8	3.9	191111411
ISO100CRVSA	304 S.S.	Viton	AS-347	100	101.6	8	3.9	191112411
ISO160CRVSA	304 S.S.	Viton	AS-362	150	152.6	8	3.9	191115411
ISO200CRVSA	304 S.S.	Viton	AS-371	210	212.6	8	3.9	191116411
ISO250CRVSA	304 S.S.	Viton	AS-378	257.5	260.4	8	3.9	191117411
ISO320CRVSA	304 S.S.	Viton	AS-454	312	317.3	12	5.6	191119411
ISO400CRVSA	304 S.S.	Viton	AS-461	394	399.2	12	5.6	191121411
ISO500CRVSA	304 S.S.	Viton	AS-469	494	500.2	12	5.6	191123411
ISO63CRVAA	Al	Viton	AS-337	67	69.6	8	3.9	191110111
ISO80CRVAA	Al	Viton	AS-341	80	82.6	8	3.9	191111111
ISO100CRVAA	Al	Viton	AS-347	100	101.6	8	3.9	191112111
ISO160CRVAA	Al	Viton	AS-362	150	152.6	8	3.9	191115111
ISO200CRVAA	Al	Viton	AS-371	210	212.6	8	3.9	191116111
ISO250CRVAA	Al	Viton	AS-378	257.5	260.4	8	3.9	191117111
ISO320CRVAA	Al	Viton	AS-454	312	317.3	12	5.6	191119111
ISO400CRVAA	Al	Viton	AS-461	394	399.2	12	5.6	191121111
ISO500CRVAA	Al	Viton	AS-469	494	500.2	12	5.6	191123111

O'Ring's color is brown, black is available upon request

ISO Centering Ring with O'Ring

Available Area :U.S.A

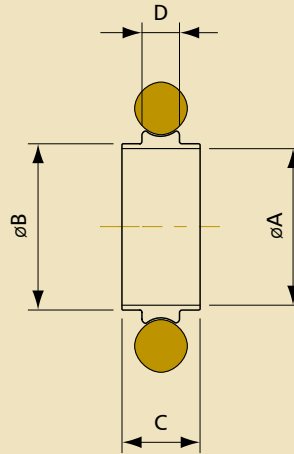

Model No.	Material C/R	O'Ring O'Ring	O'Ring Size	A	B	C	D	Parts No.
ISO63CRNSA	304 S.S.	NBR	AS-337	67	69.6	8	3.9	191310412
ISO80CRNSA	304 S.S.	NBR	AS-341	80	82.6	8	3.9	191311412
ISO100CRNSA	304 S.S.	NBR	AS-347	100	101.6	8	3.9	191312412
ISO160CRNSA	304 S.S.	NBR	AS-362	150	152.6	8	3.9	191315412
ISO200CRNSA	304 S.S.	NBR	AS-371	210	212.6	8	3.9	191316412
ISO250CRNSA	304 S.S.	NBR	AS-378	257.5	260.4	8	3.9	191317412
ISO320CRNSA	304 S.S.	NBR	AS-454	312	317.3	12	5.6	191319412
ISO400CRNSA	304 S.S.	NBR	AS-461	394	399.2	12	5.6	191321412
ISO500CRNSA	304 S.S.	NBR	AS-469	494	500.2	12	5.6	191323412
ISO63CRNAA	AI	NBR	AS-337	67	69.6	8	3.9	191310112
ISO80CRNAA	AI	NBR	AS-341	80	82.6	8	3.9	191311112
ISO100CRNAA	AI	NBR	AS-347	100	101.6	8	3.9	191312112
ISO160CRNAA	AI	NBR	AS-362	150	152.6	8	3.9	191315112
ISO200CRNAA	AI	NBR	AS-371	210	212.6	8	3.9	191316112
ISO250CRNAA	AI	NBR	AS-378	257.5	260.4	8	3.9	191317112
ISO320CRNAA	AI	NBR	AS-454	312	317.3	12	5.6	191319112
ISO400CRNAA	AI	NBR	AS-461	394	399.2	12	5.6	191321112
ISO500CRNAA	AI	NBR	AS-469	494	500.2	12	5.6	191323112

O'Ring color for NBR material is black,brown is available upon request

ISO Outer Ring Centering Ring, O'Ring

Available Area :Europe

C/R' with a notch

Special sizes available upon request

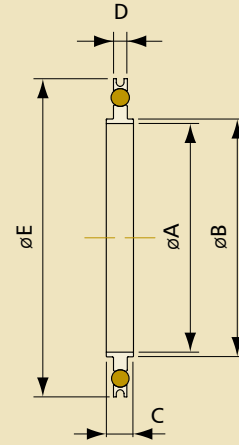

Model No.	Material		O'Ring	A	B	C	D	E	Parts No.	
	O/R	C/R	O'Ring	Size						
ISO63OCRVE	Al	304 S.S.	Viton	AS-337	68	70	8	3.9	94	192110421
ISO80OCRVE	Al	304 S.S.	Viton	AS-341	81	82.6	8	3.9	109	192111421
ISO100OCRVE	Al	304 S.S.	Viton	AS-347	100	102	8	3.9	128	192112421
ISO160OCRVE	Al	304 S.S.	Viton	AS-362	148	153	8	3.9	179	192115421
ISO200OCRVE	Al	304 S.S.	Viton	AS-371	210	213	8	3.9	238	192116421
ISO250OCRVE	Al	304 S.S.	Viton	AS-378	257.5	261	8	3.9	287	192117421
ISO320OCRVE	Al	304 S.S.	Viton	AS-454	312	318	12	5.6	344	192119421
ISO400OCRVE	Al	304 S.S.	Viton	AS-461	394	400	12	5.6	446	192121421
ISO500OCRVE	Al	304 S.S.	Viton	AS-469	494	501	12	5.6	535	192123421
ISO63OCRVAE	Al	Al	Viton	AS-337	68	70	8	3.9	94	192110121
ISO80OCRVAE	Al	Al	Viton	AS-341	81	82.6	8	3.9	109	192111121
ISO100OCRVAE	Al	Al	Viton	AS-347	100	102	8	3.9	128	192112121
ISO160OCRVAE	Al	Al	Viton	AS-362	148	153	8	3.9	179	192115121
ISO200OCRVAE	Al	Al	Viton	AS-371	210	213	8	3.9	238	192116121
ISO250OCRVAE	Al	Al	Viton	AS-378	257.5	261	8	3.9	287	192117121
ISO320OCRVAE	Al	Al	Viton	AS-454	312	318	12	5.6	344	192119121
ISO400OCRVAE	Al	Al	Viton	AS-461	394	400	12	5.6	446	192121121
ISO500OCRVAE	Al	Al	Viton	AS-469	494	501	12	5.6	535	192123121

O'Ring's color is brown, black is available upon request

ISO Outer Ring Centering Ring, O'Ring

Available Area :Europe

C/R' with a notch

Special sizes available upon request

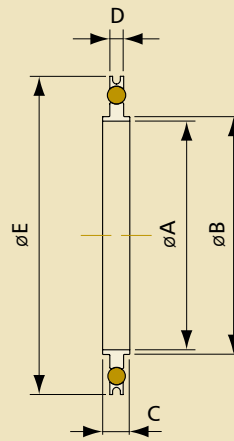

Model No.	Material		O'Ring	A	B	C	D	E	Parts No.	
	O/R	C/R	O'Ring Size							
ISO630CRNSE	Al	304 S.S.	NBR	AS-337	68	70	8	3.9	94	192310422
ISO800CRNSE	Al	304 S.S.	NBR	AS-341	81	82.6	8	3.9	109	192311422
ISO1000CRNSE	Al	304 S.S.	NBR	AS-347	100	102	8	3.9	128	192312422
ISO1600CRNSE	Al	304 S.S.	NBR	AS-362	148	153	8	3.9	179	192315422
ISO2000CRNSE	Al	304 S.S.	NBR	AS-371	210	213	8	3.9	238	192316422
ISO2500CRNSE	Al	304 S.S.	NBR	AS-378	257.5	261	8	3.9	287	192317422
ISO3200CRNSE	Al	304 S.S.	NBR	AS-454	312	318	12	5.6	344	192319422
ISO4000CRNSE	Al	304 S.S.	NBR	AS-461	394	400	12	5.6	446	192321422
ISO5000CRNSE	Al	304 S.S.	NBR	AS-469	494	501	12	5.6	535	192323422
ISO630CRNAE	Al	Al	NBR	AS-337	68	70	8	3.9	94	192310122
ISO800CRNAE	Al	Al	NBR	AS-341	81	82.6	8	3.9	109	192311122
ISO1000CRNAE	Al	Al	NBR	AS-347	100	102	8	3.9	128	192312122
ISO1600CRNAE	Al	Al	NBR	AS-362	148	153	8	3.9	179	192315122
ISO2000CRNAE	Al	Al	NBR	AS-371	210	213	8	3.9	238	192316122
ISO2500CRNAE	Al	Al	NBR	AS-378	257.5	261	8	3.9	287	192317122
ISO3200CRNAE	Al	Al	NBR	AS-454	312	318	12	5.6	344	192319122
ISO4000CRNAE	Al	Al	NBR	AS-461	394	400	12	5.6	446	192321122
ISO5000CRNAE	Al	Al	NBR	AS-469	494	501	12	5.6	535	192323122

O'Ring color for NBR material is black,brown is available upon request

ISO Outer Ring Centering Ring, O'Ring

Available Area :U.S.A

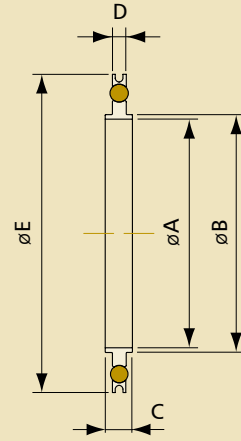

Model No.	Material		O'Ring	A	B	C	D	E	Parts No.	
	O/R	C/R	O'Ring	Size						
ISO63OCRUSA	Al	304 S.S.	Viton	AS-337	67	69.5	8	3.9	94	192110411
ISO80OCRUSA	Al	304 S.S.	Viton	AS-341	80	82.6	8	3.9	109	192111411
ISO100OCRUSA	Al	304 S.S.	Viton	AS-347	100	101.6	8	3.9	128	192112411
ISO160OCRUSA	Al	304 S.S.	Viton	AS-362	150	152.6	8	3.9	179	192115411
ISO200OCRUSA	Al	304 S.S.	Viton	AS-371	210	212.6	8	3.9	238	192116411
ISO250OCRUSA	Al	304 S.S.	Viton	AS-378	257.5	260.4	8	3.9	287	192117411
ISO320OCRUSA	Al	304 S.S.	Viton	AS-454	312	317.3	12	5.6	344	192119411
ISO400OCRUSA	Al	304 S.S.	Viton	AS-461	394	399.2	12	5.6	446	192121411
ISO500OCRUSA	Al	304 S.S.	Viton	AS-469	494	500.2	12	5.6	535	192123411
ISO63OCRVA	Al	Al	Viton	AS-337	67	69.5	8	3.9	94	192110111
ISO80OCRVA	Al	Al	Viton	AS-341	80	82.6	8	3.9	109	192111111
ISO100OCRVA	Al	Al	Viton	AS-347	100	101.6	8	3.9	128	192112111
ISO160OCRVA	Al	Al	Viton	AS-362	150	152.6	8	3.9	179	192115111
ISO200OCRVA	Al	Al	Viton	AS-371	210	212.6	8	3.9	238	192116111
ISO250OCRVA	Al	Al	Viton	AS-378	257.5	260.4	8	3.9	287	192117111
ISO320OCRVA	Al	Al	Viton	AS-454	312	317.3	12	5.6	344	192119111
ISO400OCRVA	Al	Al	Viton	AS-461	394	399.2	12	5.6	446	192121111
ISO500OCRVA	Al	Al	Viton	AS-469	494	500.2	12	5.6	535	192123111

O'Ring's color is brown, black is available upon request

ISO Outer Ring Centering Ring, O'Ring

Available Area :U.S.A

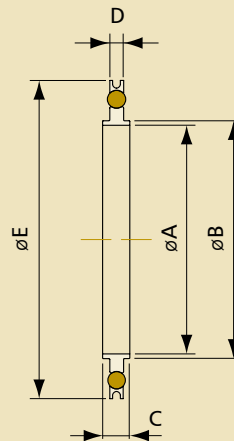

Model No.	Material		O'Ring	A	B	C	D	E	Parts No.	
	O/R	C/R								O'Ring Size
ISO63OCRNSA	AI	304 S.S.	NBR	AS-337	67	69.5	8	3.9	94	192310412
ISO80OCRNSA	AI	304 S.S.	NBR	AS-341	80	82.6	8	3.9	109	192311412
ISO100OCRNSA	AI	304 S.S.	NBR	AS-347	100	101.6	8	3.9	128	192312412
ISO160OCRNSA	AI	304 S.S.	NBR	AS-362	150	152.6	8	3.9	179	192315412
ISO200OCRNSA	AI	304 S.S.	NBR	AS-371	210	212.6	8	3.9	238	192316412
ISO250OCRNSA	AI	304 S.S.	NBR	AS-378	257.5	260.4	8	3.9	287	192317412
ISO320OCRNSA	AI	304 S.S.	NBR	AS-454	312	317.3	12	5.6	344	192319412
ISO400OCRNSA	AI	304 S.S.	NBR	AS-461	394	399.2	12	5.6	446	192321412
ISO500OCRNSA	AI	304 S.S.	NBR	AS-469	494	500.2	12	5.6	535	192323412
ISO63OCRNAA	AI	AI	NBR	AS-337	67	69.5	8	3.9	94	192310112
ISO80OCRNAA	AI	AI	NBR	AS-341	80	82.6	8	3.9	109	192311112
ISO100OCRNAA	AI	AI	NBR	AS-347	100	101.6	8	3.9	128	192312112
ISO160OCRNAA	AI	AI	NBR	AS-362	150	152.6	8	3.9	179	192315112
ISO200OCRNAA	AI	AI	NBR	AS-371	210	212.6	8	3.9	238	192316112
ISO250OCRNAA	AI	AI	NBR	AS-378	257.5	260.4	8	3.9	287	192317112
ISO320OCRNAA	AI	AI	NBR	AS-454	312	317.3	12	5.6	344	192319112
ISO400OCRNAA	AI	AI	NBR	AS-461	394	399.2	12	5.6	446	192321112
ISO500OCRNAA	AI	AI	NBR	AS-469	494	500.2	12	5.6	535	192323112

O'Ring color for NBR material is black,brown is available upon request